

NEB200

Handheld Compressor Nebulizer

INSTRUCTIONS



Thank you for purchasing the Sunset NEB200 Handheld Compressor Nebulizer. These instructions provide important information to help you use the system properly. Before using this product, please read the following contents thoroughly and carefully.

If you have other questions regarding this product, please contact the place of purchase.

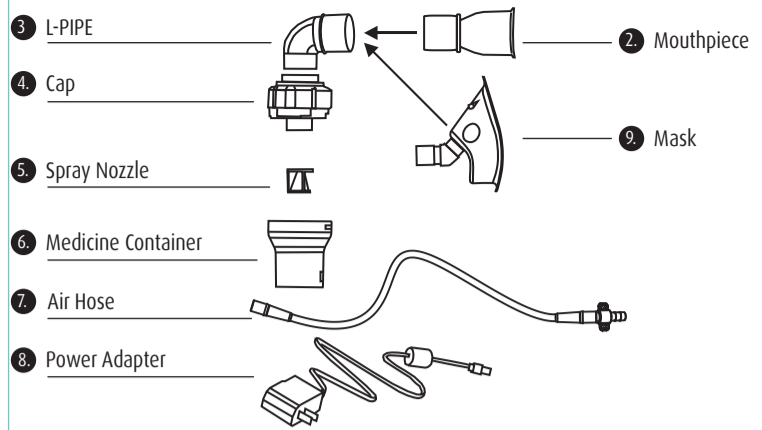

SAFETY PRECAUTIONS

- Use the equipment only for its intended use as described in these instructions. Use only attachments that are recommended by the manufacturer.
- Use the equipment only with medications under the instructions of your physician.
- Do not use the equipment if it has any damaged parts, or it has fallen into water.
- To use the equipment for the first time, after storing it for an extended period, and after every use, clean all necessary parts as described in the cleaning instructions.
- Do not use while bathing.
- The unit should not be left unattended while plugged in or turned on.
- Keep the unit out of reach of small unsupervised children.
- Keep the small parts detached from the device away from children, as they may result in choking, inhaling, or swallowing.
- Do not try to modify the device.
- Do not place the device in liquid, nor put it where it could fall into liquid. If the device becomes wet, unplug the device before touching it.
- Do not use the device if it is not working properly, or if it has incurred any damage.
- Do not drop the nebulizer or subject it to impact.
- Do not expose the nebulizer to direct sunlight, high temperatures or humidity.
- The nebulizer is NOT suitable for use in anaesthetic breathing systems or lung ventilator breathing systems.

IMPORTANT INFORMATION ABOUT INHALATION THERAPY

The device is ideally suitable for inhalation at home or when travelling. It guarantees highly effective, fast-acting inhalation treatment for patients of all ages. Carry out inhalation in a quiet and relaxed state, and inhale slowly and deeply, so that the medication can penetrate to the fine, deep bronchial tubes. Exhale normally.

OPERATING INSTRUCTIONS

Important Information Before Use

- Ensure that all parts are clean and dry.
- Before starting treatment, talk to your physician about the duration, dosage and frequency of use of the nebulizer.
- The device is designed for an intermittent use: 30 minutes ON / 30 minutes OFF.
- Do not remove the medication container cover from the unit during nebulization.
- Test the nebulizer to make sure it is functioning correctly by pouring drinking water (2 to 5 ml) into the medicine container. Press the power switch to turn on the device and to check if it is working properly. Turn off the unit, and discard any remaining water. Then you may begin actual treatment by following medication instructions.
- The device does not heat the medication container under operation. Please follow the recommended volume of medicine capacity.

Unit Assembly and Usage

1. Correctly position the spray nozzle inside the medicine container.
2. Slowly pour the prescribed medication into the medicine container. The maximum capacity of the container is 6 ml. Please note that the medication must not exceed this maximum level marking (6 ml).
3. Correctly fit the polished area on cap and medicine container by slightly closing and turning clockwise. Make sure both are closed well until the lines marked on the cap and medicine container are in alignment. Connect the mouthpiece / mask (optional) and L-PIPE, and then attach to the top of the cap.

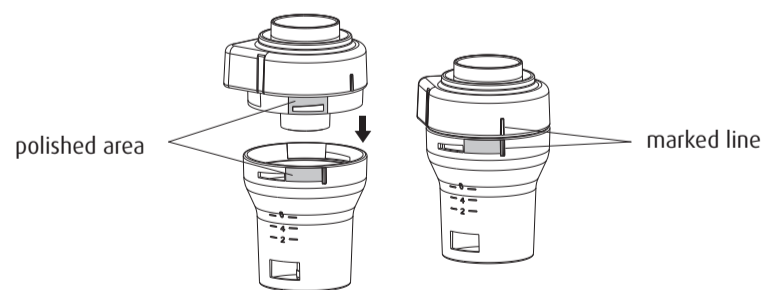

INTENDED USE

The NEB200 Handheld Compressor Nebulizer is designed to provide a compressed air source to aerosolize physician-prescribed liquid medication when used in combination with the packaged Nebulizer kit, except for Pentamidine. The packaged Nebulizer kit is intended for single patient use. The NEB200 Handheld Compressor Nebulizer is intended for use with children and adult patients in the homecare settings.

ITEMS SUPPLIED AND PACKAGING

Before you start to use the Handheld Compressor Nebulizer, please check if the following items are included in the package:

- | | | |
|-------------------------|-------------------|------------------|
| 1. 1 compressor | } nebulizer kit } | 8. Power Adapter |
| 2. 1 mouthpiece * | | • Instructions |
| 3. 1 L-PIPE | | 9. Mask |
| 4. 1 cap | | |
| 5. 1 spray nozzle | | |
| 6. 1 medicine container | | |
| 7. 1 air hose | | |

* NOTE

- For good hygiene, please use the mouthpiece, mask and nebulizer kit for one specific individual only and do not exchange them.
- The lifetime of the reusable parts are as follows. Frequent use of the product may shorten the lifetime.
Air hose: 1 year
Compressor: 3 years

FEATURES

- Does not use heat so the medicine does not incur heat damage
- Low power consumption
- Small nebulization particle size - 1-5 microns
- Convenient design - compact and lightweight, ideal for travelling
- Short treatment time with high nebulization rate

DESCRIPTIONS OF PARTS

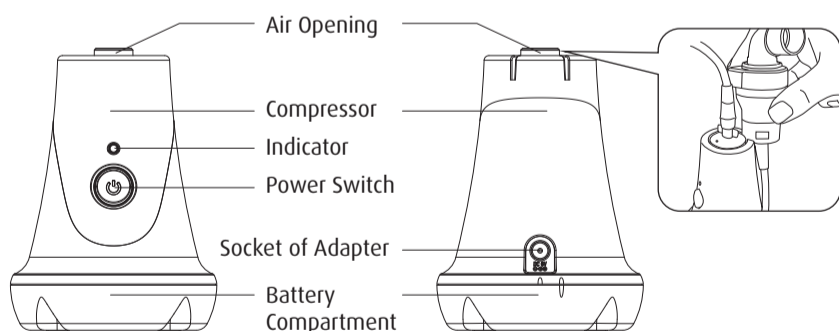

NOTE

The mouthpiece should only be used for oral inhalation.

- To use the nebulizer, you may put together the compressor and the medicine cup with the air hose or simply place the medicine cup on top.
- Plug the Power Adapter into the wall outlet; plug the power cord of the adapter into the socket on the side of the compressor.
- Press the power switch to turn on the device. Begin treatment according to your physician's instructions.
- Inhale and exhale naturally. Be sure to stop when the medication is exhausted.

NOTE

When you have completed treatment, press the power switch to turn the device off before you disconnect the air hose. Unplug the power cord, remove the inhalation accessories used and proceed with cleaning operations as described in the "Cleaning and Maintenance" section.

Inhalation with Mouthpiece and Mask

How to use the mouthpiece

- Insert the mouthpiece into the L-PIPE.
- Close your lips around the mouthpiece and start treatment as recommended by your doctor.

How to use the mask

- Insert the mask into the L-PIPE.
- Place the mask onto your face and start treatment as recommended by your doctor.

CLEANING AND MAINTENANCE

Please clean your device after each use according to the instructions below.

Before Cleaning

Make sure that the nebulizer is turned off before disassembly.

Cleaning of Nebulizer Parts/Accessories

- After you have disconnected the air hose, remove the mouthpiece / mask (optional), L-PIPE, cap, spray nozzle and medicine container.
- Discard any remaining medication.
- Wash mouthpiece / mask (optional), L-PIPE, cap, spray nozzle and medicine container with running water or soak in warm water for 15 minutes.
- Gently wipe off excess water with a clean dry cloth and allow to air dry on a clean paper towel.

Cleaning of Compressor

- Use cotton swabs with alcohol to wipe the outer casing of the compressor.
- Let it air dry on a clean paper towel.

Replacing the Battery

- The indicator turning red means the battery capacity is low. Please change batteries immediately.
- Turn off the meter, and then hold the unit upside down with the battery compartment on top.
- Open the battery compartment by turning the top in counterclockwise direction. Put the lid aside for later use.
- Replace the batteries with new ones and place them accordingly.
- Place the lid back by screw it down in clockwise direction.

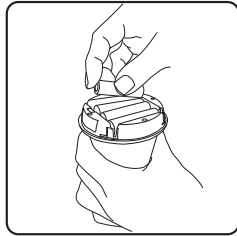
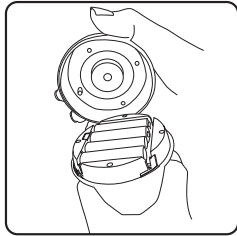
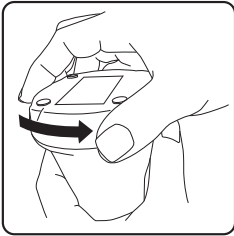

NOTE

- The above-named accessories can be regarded as consumable items, please replace with new one if it becomes dirty and obstructed. In consideration of the risk of cross-contamination, do not share the accessories with others.
- Only can use the aerosol nebulizer kit manufactured by TaiDoc for appropriate assembly.

Maintenance for Storage

- Always handle your nebulizer with care.
- Disconnect the power plug (optional) from the wall outlet when not in use.
- Keep your nebulizer out of reach of children.
- If you store your nebulizer, do not bend the air hose.
- If you store your nebulizer, try to keep it in the following environmental ranges:
 - Temperature: -13°F to 158°F (-25°C to 70°C),
 - Relative humidity: 10% to 95%
- If possible, store your nebulizer in a well-ventilated room.

METER DISPOSAL

The used compressor nebulizer should be treated as contaminated that may carry a risk of infection during nebulization. The compressor nebulizer should be disposed in accordance with local regulations.

SYMBOL INFORMATION

Symbol	Referent	Symbol	Referent
	Consult instructions for use		Type BF Equipment
	Caution, consult accompanying documents		Humidity limitation
	Temperature limitation	IP22	Ingress protection rating

TROUBLESHOOTING

Symptom	Probable Cause	Solution
The device does not work or the device is on but nebulizes weakly.	The plug is improperly inserted into the device.	Re-plug again and make sure that the plug is properly inserted into the device.
	Compressor switch is off.	Turn the switch on.
	Air hose is bent.	Remove any bend or kink in the air hose.
	The spray nozzle is loose or crooked.	Place the spray nozzle in its correct position.
The device is on but does not nebulize.	No medicine is left.	Add the appropriate amount of medicine prescribed by your physician to the medicine container.
	The medicine container and cap does not fit together well.	Carefully re-assemble the medicine container and cap and twist them together well.
	Medicine texture is too thick.	Shake the medicine, then nebulization will be produced.

SPECIFICATIONS

Model Number: NEB200

Dimension & Weight: 115 x 85 x 207 mm; 205 g

Power Source: DC 6V or 4 AA batteries

Power Consumption: 6 W

Compressor Pressure Range: 90 to 138 kPa

Operating Pressure Range: 35 to 69 kPa

Maximum Flow Rate: ≥ 3 LPM(l/min)

Noise Level: 60 dBA

IP Classification: IP22

Mode of Operation: 30 mins on/ 30 mins off

Nebulization Rate: ≥ 0.25 ml/min

Medication Capacity: 6 ml (maximum) / 2 ml (minimum)

MMAD: Approximately 3 microns

Aerosol Output: 1.8 ± 0.05 (ml)*

Aerosol Output Rate: 0.32 ± 0.003 (ml/min)**

Operating conditions: 41°F to 104°F (5°C to 40°C), 15% to 93% relative humidity, 700 hPa to 1060 hPa

Storage conditions: -13°F to 158°F (-25°C to 70°C), 10% to 95% relative humidity

-specification-

Plot of cumulative size distribution of results for particle size

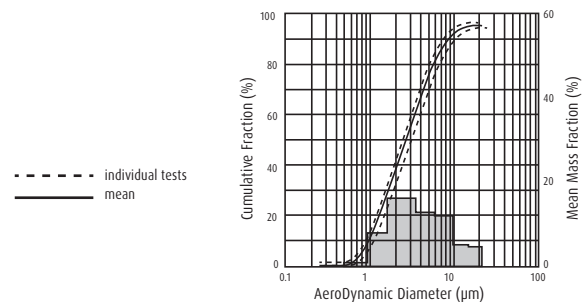

* : Continue the treatment until the medicine cup is empty or the mist stops.

** : The treatment time for aerosol output rate is 1 min.

NOTE

Please contact your place of purchase for assistance with any other difficulties.

- Performance may vary with properties of medication such as suspensions or high viscosity. See medication supplier's data sheet for further details.

Reference to Standards:

- Electric Safety Standards IEC 60601-1, IEC 60601-1-11
- Electromagnetic Compatibility according to EN 60601-1-2
- Particle Size according to EN 13544-1

Manufactured for

Sunset Healthcare Solutions

180 N Michigan Ave Ste 2000

Chicago, IL 60601

www.SunsetHCS.com

NEB200-IFU

V 1.0

311-7014300-XXX